

DMC 200S - OPEN FRAMING

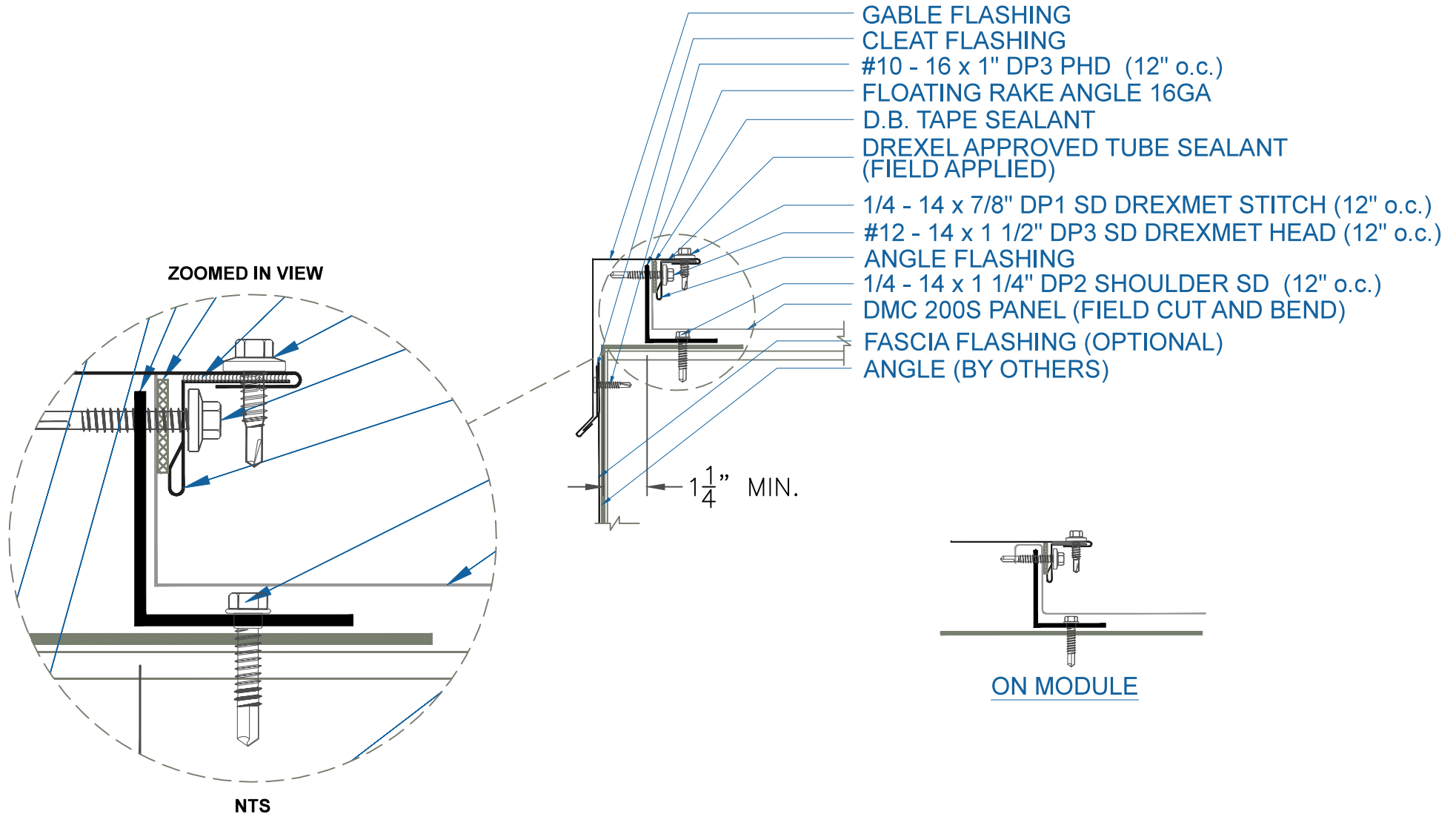

EFFECTIVE DATE: 01-18-13
 SUBJECT TO CHANGE WITHOUT NOTICE

GABLE
 SCALE: 3" = 1'-0"

DrexelMetals
 Roofing Systems + Custom Fabrication

